

SISTEMI SLV TRACK

Sistema di binari elettrificati trifase
per progetti professionali



sempre aggiornato !

scarica il listino prezzi attuale

KS-Luce.it/listino_prezzi_TRIFASE

o scansionare il codice qr qui sotto!



[Qui](#) potete trovare i nostri termini e condizioni generali per i clienti commerciali



KS e SLV: partner forti nell'illuminazione da 30 anni

CENTRO DI RACCOLTA A ESSEN

Da 30 anni KS Licht- und Elektrotechnik GmbH integra i prodotti e i servizi SLV con un'ampia gamma di servizi. Abbiamo un centro di raccolta per i prodotti SLV nel cuore della Ruhr, dove potete ritirare la merce ordinata da noi con breve preavviso.

VIVERE L'ESPERIENZA DEGLI APPARECCHI SLV DAL VIVO

Presentiamo un'ampia selezione di apparecchi SLV su oltre 300 m² di spazio espositivo. Qui i nostri consulenti e lighting designer professionisti vi consiglieranno personalmente. Allo stesso tempo, potete utilizzare la nostra esposizione per presentare ai vostri clienti i nostri apparecchi in termini di funzione ed effetto. Convincetevi della qualità dei nostri apparecchi per esterni nell'esposizione all'aperto.

PROGETTAZIONE ILLUMINOTECNICA GRATUITA

Sviluppiamo soluzioni di illuminazione pratiche insieme a voi e in base alle vostre esigenze. Che si tratti di locali commerciali, sale di vendita o ambienti privati: i nostri progettisti illuminotecnici hanno sempre i concetti giusti per una soluzione orientata alla domanda e all'energia. Saremo lieti di calcolare per voi il tempo di ammortamento della vostra nuova illuminazione LED a risparmio energetico.

NEGOZIO ONLINE DI APPARECCHI D'ILLUMINAZIONE MULTIMARCA KS

Nel nostro negozio online www.KS-Luce.it troverete tutto ciò che vi supporta nel vostro lavoro quotidiano:

- Offerte speciali e nuovi prodotti
- Verifica online della disponibilità dei prodotti
- Trovare e ordinare facilmente tutti i pezzi di ricambio
- Modulo d'ordine rapido
- Tutti i cataloghi sono disponibili per il download o come catalogos fogliabile con link al prodotto
- Testi delle specifiche, curve di distribuzione della luce/ LDT e plug-in Tabelle di calcolo rapido

KS Licht- u. Elektrotechnik GmbH
Manderscheidstr. 8c
45141 Essen

Tel.: +49 (0)201-89924-0
Fax: +49 (0)201-89924-124

Onlineshop: www.KS-Luce.it
Internet: www.KS-Germany.com
Email: Verkauf@KS-Germany.com

Venite a trovarci in loco o chiamateci:
Da lunedì a giovedì dalle 08.00 alle 16.30
Venerdì dalle 08.00 alle 15.00

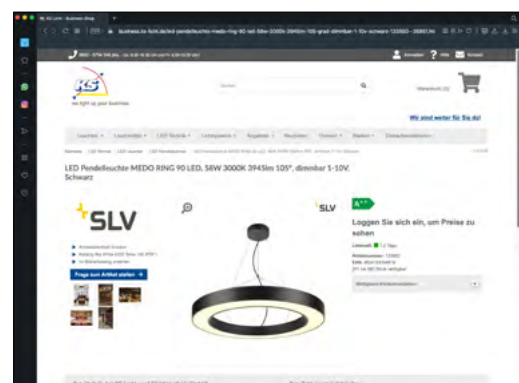
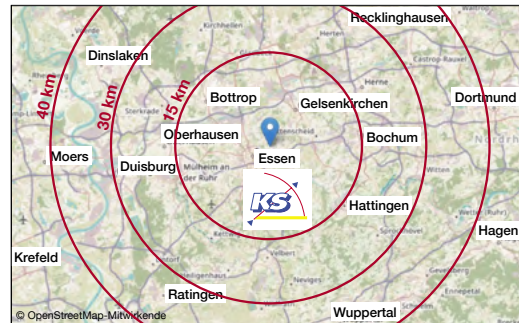

Scannerizzate il link al nostro modulo d'ordine rapido e ottenete informazioni aggiornate sulla disponibilità della merce!



<https://www.ks-luce.it/formulario-per-ordini-veloce>



Quando la situazione si fa tecnicamente complessa, grazie ai numerosi elementi a binario liberamente combinabili tra loro, è possibile superare qualsiasi sfida di progettazione illuminotecnica.

SOMMARIO

SISTEMA SLV S-TRACK

Binario a plafone trifase e accessori **6-9**

APPARECCHI TRIFASE

NUMINOS® S, M, L **10-15**

NUMINOS® S, M, L DALI **16-21**

SIGHT MOVE DALI **22-23**

SIGHT TRACK DALI **24-25**

ONE 40 TRACK DALI **26-27**

EUTRAC® SYSTEM

Binario a plafone trifase e accessori **28-31**

EUTRAC® SYSTEM

Binario da incasso trifase e accessori **32-33**

COMPATIBILITÀ

Binari elettrificati trifase **34-35**

NUMINOS® CONFIGURATORE

Configurazione online spot **36-37**

LEGENDA DEI SIMBOLI

39



S-TRACK

Binario a plafone trifase DALI

I vostri binari professionali.

I binari elettrificati trifase S-TRACK sono ideali per negozi, musei, hotel, ristoranti o abitazioni. Grazie all'elevato numero di faretti ad alte prestazioni è possibile realizzare svariati scenari di luce, attivabili singolarmente con circuiti elettrici separati.

- Ampia selezione di faretti ad alte prestazioni
- Circuiti elettrici comandabili separatamente
- Un solo punto luce per sistemi complessi
- Su misura grazie alle lunghezze disponibili
- Compatibilità DALI per progetti illuminotecnici smart

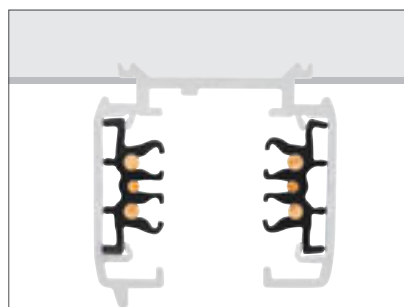

	1 m	1 m	2 m	2 m
Tensione nominale (V)	220-240V ~50/60Hz	220-240V ~50/60Hz	220-240V ~50/60Hz	220-240V ~50/60Hz
Intensità di corrente massima (A)	16	16	16	16
Carico meccanico max.	30 kg	30 kg	30 kg	30 kg
Materiale	Alluminio	Alluminio	Alluminio	Alluminio
Colore	■ nero	□ bianco	■ nero	□ bianco
L x P x A (cm)	100 x 3,6 x 3,6	100 x 3,6 x 3,6	200 x 3,6 x 3,6	200 x 3,6 x 3,6
Peso (kg)	0,9	0,9	1,84	1,84
Codice articolo	1004937	1004938	1002631	1002632



	3 m	3 m	4 m	4 m
Tensione nominale (V)	220-240V ~50/60Hz	220-240V ~50/60Hz	220-240V ~50/60Hz	220-240V ~50/60Hz
Intensità di corrente massima (A)	16	16	16	16
Carico meccanico max.	30 kg	30 kg	30 kg	30 kg
Materiale	Alluminio	Alluminio	Alluminio	Alluminio
Colore	■ nero	□ bianco	■ nero	□ bianco
L x P x A (cm)	300 x 3,6 x 3,6	300 x 3,6 x 3,6	400 x 3,6 x 3,6	400 x 3,6 x 3,6
Peso (kg)	2,76	2,76	3,53	3,53
Codice articolo	1002633	1002634	1002635	1002636

S-TRACK

Binario a plafone trifase DALI

Guida alla progettazione e panoramica degli accessori

Vista dei componenti dall'alto

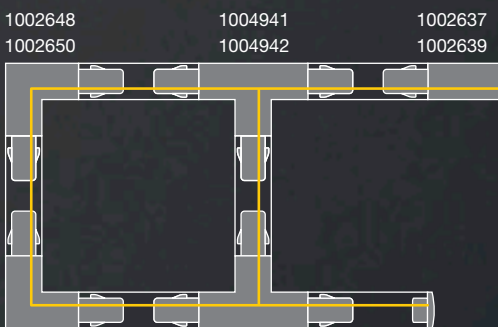
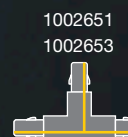
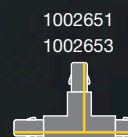
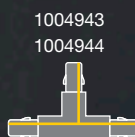
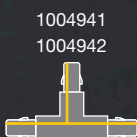
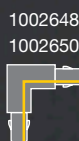
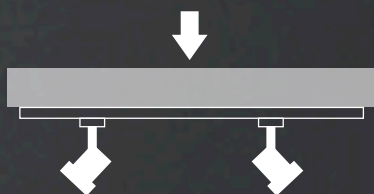







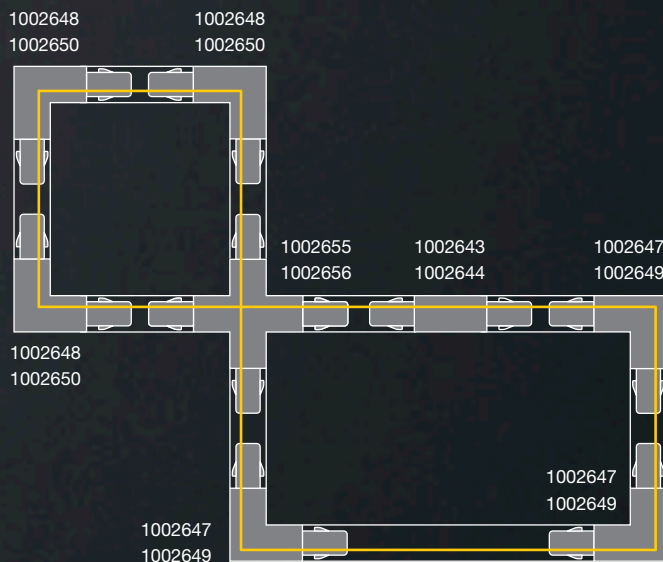

1002648
1002650

1004943
1004944

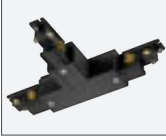
1001380
175060/64

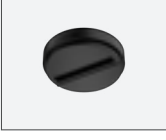

	Testata di alimentazione, DALI, terra a sinistra 10A max. Policarbonato (PC) L: 13,9 cm La: 3,5 cm H: 3,3 cm ■ nero Cod. art. 1002637 □ bianco Cod. art. 1002639		Raccordo di isolamento Policarbonato (PC) L: 6,8 cm La: 3,1 cm H: 2,6 cm ■ nero Cod. art. 175080 □ bianco Cod. art. 1001382
	Testata di alimentazione, DALI, terra a destra 16A max. Policarbonato (PC) L: 13,9 cm La: 3,5 cm H: 3,3 cm ■ nero Cod. art. 1002638 □ bianco Cod. art. 1002640		Staffa di fissaggio Acciaio L: 4 cm La: 3,4 cm H: 1,25 cm ■ nero Cod. art. 1002657 □ bianco Cod. art. 1002658
	Giunto a L, DALI, terra esterna 16A max. Policarbonato (PC) L: 11,9 cm La: 11,9 cm H: 3,3 cm ■ nero Cod. art. 1002647 □ bianco Cod. art. 1002649		Adattatore trifase per sospensione, DALI 10A max. Policarbonato (PC) L: 11,3 cm La: 5,5 cm H: 3,3 cm ■ nero Cod. art. 1002660 □ bianco Cod. art. 1002659
	Giunto a L, DALI, terra interna 16A max. Policarbonato (PC) L: 11,9 cm La: 11,9 cm H: 3,3 cm ■ nero Cod. art. 1002648 □ bianco Cod. art. 1002650		Adattatore trifase meccanico Alluminio/policarbonato (PC) L: 6,6 cm La: 6,6 cm H: 3,1 cm ■ nero Cod. art. 175210 □ bianco Cod. art. 1001395
	Raccordo a T, DALI, terra esterna, sinistra* 16A max. Policarbonato (PC) L: 20,3 cm La: 11,9 cm H: 3,3 cm ■ nero Cod. art. 1002652 □ bianco Cod. art. 1002654		Copertura Policarbonato (PC) L: 200 cm La: 2,2 cm H: 0,75 cm ■ nero Cod. art. 1004939 □ bianco Cod. art. 1004940
	Raccordo a T, Dali, terra esterna, destra* 16A max. Policarbonato (PC) L: 20,3 cm La: 11,9 cm H: 3,3 cm ■ nero Cod. art. 1002651 □ bianco Cod. art. 1002653		Calotta di chiusura Policarbonato (PC) L: 3,5 cm La: 3,3 cm H: 3,2 cm ■ nero Cod. art. 175060 □ bianco Cod. art. 1001380
	Raccordo a T, DALI, terra interna, sinistra* 16A max. Policarbonato (PC) L: 20,3 cm La: 11,9 cm H: 3,3 cm ■ nero Cod. art. 1004941 □ bianco Cod. art. 1004942		Tige di sospensione Alluminio/policarbonato (PC) L: 6 cm La: 6 cm H: 4 cm max. 10 kg ■ nero Cod. art. 175160 □ bianco Cod. art. 1001390
	Raccordo a T, DALI, terra interna, destra* 16A max. Policarbonato (PC) L: 20,3 cm La: 11,9 cm H: 3,3 cm ■ nero Cod. art. 1004943 □ bianco Cod. art. 1004944		Gancio di accoppiamento Alluminio L: 18,2 cm La: 3,3 cm H: 2,1 cm ■ nero Cod. art. 175180 □ bianco Cod. art. 1001392
	Raccordo a X, DALI* 16A max. Policarbonato (PC) L: 20,3 cm La: 20,3 cm H: 3,3 cm ■ nero Cod. art. 1002655 □ bianco Cod. art. 1002656		Gancio Policarbonato (PC) / acciaio H: 5,2 cm Ø: 2,6 cm max. 10 kg ■ nero Cod. art. 175190 □ bianco Cod. art. 1001393
	Raccordo longitudinale, DALI 16A max. Policarbonato (PC) L: 10,6 cm La: 2,5 cm H: 2,8 cm ■ nero Cod. art. 1002641 □ bianco Cod. art. 1002642		Rosone a plafone 16A max. Policarbonato (PC) H: 3,56 cm Ø: 14,32 cm ■ nero Cod. art. 1004684 □ bianco Cod. art. 1004685
	Raccordo longitudinale, DALI* 10A max. Policarbonato (PC) L: 20,3 cm La: 3,5 cm H: 3,3 cm ■ nero Cod. art. 1002643 □ bianco Cod. art. 1002644		Cavo di sospensione, 2 pezzi Acciaio inox/ottone L: 500 cm max. 10 kg ■ nichel Cod. art. 1002845
	Raccordo flessibile, DALI 16A max. Policarbonato (PC) L: 28,5 cm La: 3,5 cm H: 3,3 cm ■ nero Cod. art. 1002645 □ bianco Cod. art. 1002646		

* con possibilità di alimentazione



Disponibile con diversi flussi luminosi,
temperature di colore e fasci di luce

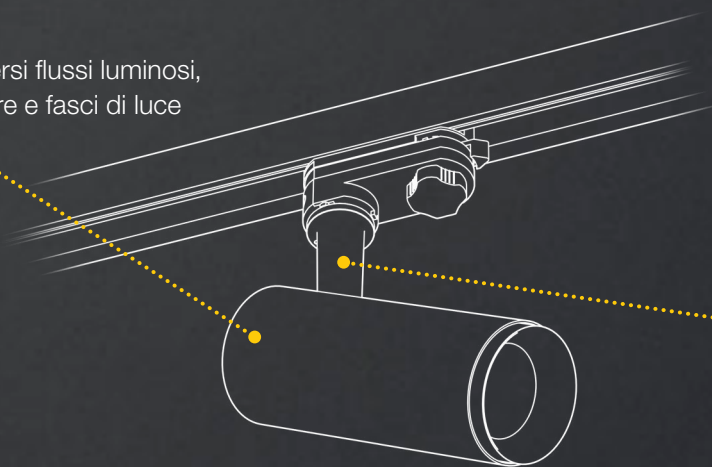

Orientabili di 90°
e ruotabili di 350°



Qui trovi il configuratore online SLV NUMINOS®:
www.ks-luce.it/numinos-configuratori-it

NUMINOS® S



NUMINOS® S



50000 350° 90° 0,53

Tensione nominale (V)	220-240V ~50/60Hz 250mA
Potenza assorbita (W)	11
CRI	90
Materiale	Alluminio/plastica
L / Ø / H (cm)	16,2 / 6,5 / 14,5



■ nero

Temperatura colore (K)	2700K	2700K	2700K	3000K	3000K	3000K	4000K	4000K	4000K
Flusso luminoso (lm)	985lm	985lm	980lm	1020lm	1020lm	1020lm	1100lm	1100lm	1100lm
Angolo	24°	36°	60°	24°	36°	60°	24°	36°	60°
Codice articolo	1004074	1004075	1004076	1004082	1004083	1004084	1004090	1004091	1004092

□ bianco

Temperatura colore (K)	2700K	2700K	2700K	3000K	3000K	3000K	4000K	4000K	4000K
Flusso luminoso (lm)	985lm	985lm	980lm	1020lm	1020lm	1020lm	1100lm	1100lm	1100lm
Angolo	24°	36°	60°	24°	36°	60°	24°	36°	60°
Codice articolo	1004078	1004079	1004080	1004086	1004087	1004088	1004094	1004095	1004096



Potenza ideale per negozi e uffici
di medie dimensioni

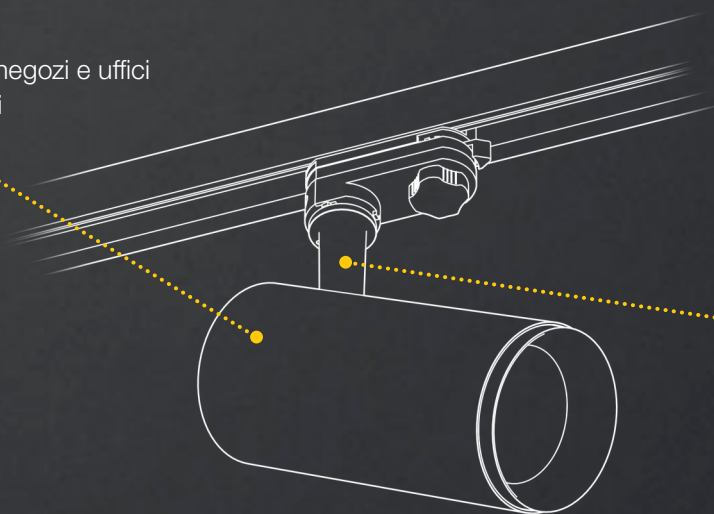

Orientabili di 90°
e ruotabili di 350°

Qui trovi il configuratore online SLV NUMINOS®:
www.ks-luce.it/numinos-configuratori-it

NUMINOS® M



50000 350° 90° 0,72

Tensione nominale (V)	220-240V ~50/60Hz 500mA
Potenza assorbita (W)	20
CRI	90
Materiale	Alluminio/plastica
L / Ø / H (cm)	18,5 / 8,5 / 16,5



■ nero

Temperatura colore (K)	2700K	2700K	2700K	3000K	3000K	3000K	4000K	4000K	4000K
Flusso luminoso (lm)	1925lm	1935lm	1885lm	1955lm	1970lm	1880lm	2125lm	2120lm	2060lm
Angolo	24°	36°	60°	24°	36°	60°	24°	36°	60°
Codice articolo	1004170	1004171	1004172	1004178	1004179	1004180	1004186	1004187	1004188

□ bianco

Temperatura colore (K)	2700K	2700K	2700K	3000K	3000K	3000K	4000K	4000K	4000K
Flusso luminoso (lm)	1925lm	1935lm	1885lm	1955lm	1970lm	1880lm	2125lm	2120lm	2060lm
Angolo	24°	36°	60°	24°	36°	60°	24°	36°	60°
Codice articolo	1004174	1004175	1004176	1004182	1004183	1004184	1004190	1004191	1004192



Potenza elevata per negozi di grandi dimensioni e spazi ampi

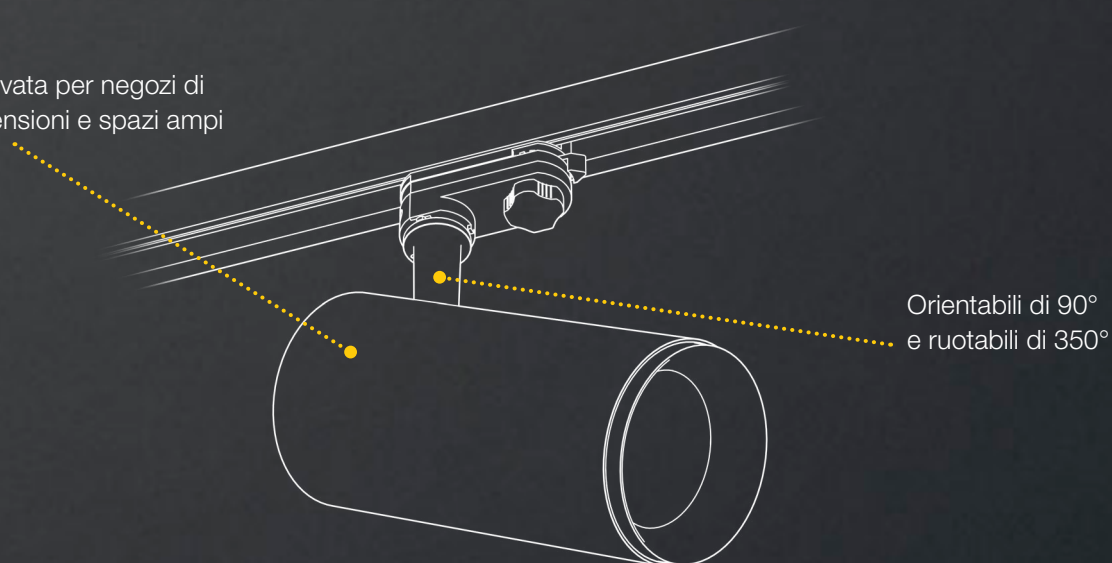

Orientabili di 90°
e ruotabili di 350°



Qui trovi il configuratore online SLV NUMINOS®:
www.ks-luce.it/numinos-configuratori-it

NUMINOS® L



NUMINOS® L



Tensione nominale (V)	220-240V ~50/60Hz 700mA
Potenza assorbita (W)	28
CRI	90
Materiale	Alluminio/plastica
L / Ø / H (cm)	21,3 / 10 / 18



■ nero

Temperatura colore (K)	2700K	2700K	2700K	3000K	3000K	3000K	4000K	4000K	4000K
Flusso luminoso (lm)	2440lm	2400lm	2475lm	2430lm	2340lm	2400lm	2675lm	2620lm	2715lm
Angolo	24°	36°	60°	24°	36°	60°	24°	36°	60°
Codice articolo	1004266	1004267	1004268	1004274	1004275	1004276	1004282	1004283	1004284

□ bianco

Temperatura colore (K)	2700K	2700K	2700K	3000K	3000K	3000K	4000K	4000K	4000K
Flusso luminoso (lm)	2440lm	2400lm	2475lm	2430lm	2340lm	2400lm	2675lm	2620lm	2715lm
Angolo	24°	36°	60°	24°	36°	60°	24°	36°	60°
Codice articolo	1004270	1004271	1004272	1004278	1004279	1004280	1004286	1004287	1004288



Potenza inferiore e luce comandata
tramite sistema DALI

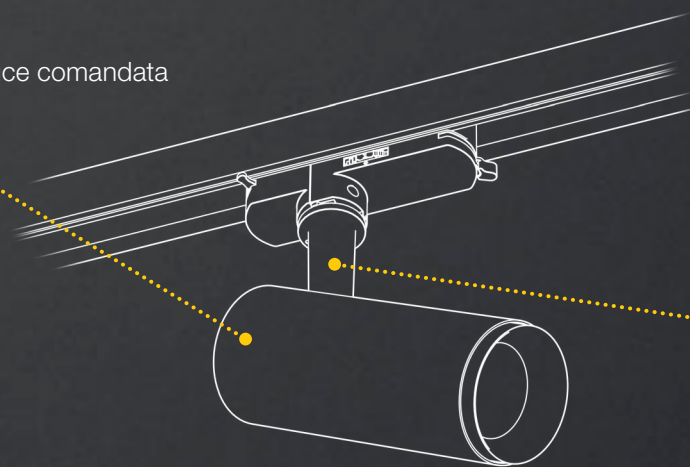

Orientabili di 90°
e ruotabili di 350°



Qui trovi il configuratore online SLV NUMINOS®:
www.ks-luce.it/numinos-configuratori-it

NUMINOS® S

DALI

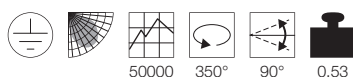

50000 350° 90° 0,53

Tensione nominale (V)	220-240V ~50/60Hz 250mA
Potenza assorbita (W)	11
CRI	90
Materiale	Alluminio/plastica
L / Ø / H (cm)	16,2 / 6,5 / 14,5



■ nero

Temperatura colore (K)	2700K	2700K	2700K	3000K	3000K	3000K	4000K	4000K	4000K
Flusso luminoso (lm)	985lm	985lm	980lm	1020lm	1020lm	1020lm	1100lm	1100lm	1100lm
Angolo	24°	36°	60°	24°	36°	60°	24°	36°	60°
Codice articolo	1004362	1004363	1004364	1004370	1004371	1004372	1004378	1004379	1004380

□ bianco

Temperatura colore (K)	2700K	2700K	2700K	3000K	3000K	3000K	4000K	4000K	4000K
Flusso luminoso (lm)	985lm	985lm	980lm	1020lm	1020lm	1020lm	1100lm	1100lm	1100lm
Angolo	24°	36°	60°	24°	36°	60°	24°	36°	60°
Codice articolo	1004366	1004367	1004368	1004374	1004375	1004376	1004382	1004383	1004384



Potenza intermedia e luce comandata
tramite sistema DALI

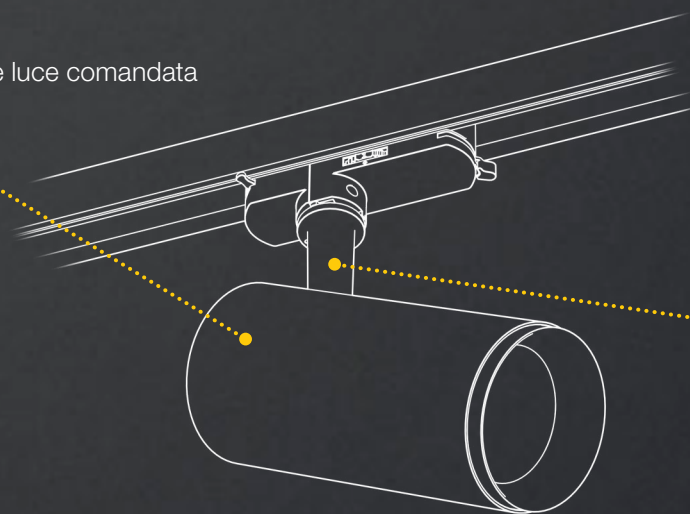

Orientabili di 90°
e ruotabili di 350°



Qui trovi il configuratore online SLV NUMINOS®:
www.ks-luce.it/numinos-configuratori-it

NUMINOS® M

DALI

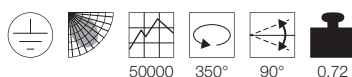

50000 350° 90° 0,72

Tensione nominale (V)	220-240V ~50/60Hz 500mA
Potenza assorbita (W)	20
CRI	90
Materiale	Alluminio/plastica
L / Ø / H (cm)	18,5 / 8,5 / 16,5



■ nero

Temperatura colore (K)	2700K	2700K	2700K	3000K	3000K	3000K	4000K	4000K	4000K
Flusso luminoso (lm)	1925lm	1935lm	1885lm	1955lm	1970lm	1880lm	2125lm	2120lm	2060lm
Angolo	24°	36°	60°	24°	36°	60°	24°	36°	60°
Codice articolo	1004458	1004459	1004460	1004466	1004467	1004468	1004474	1004475	1004476

□ bianco

Temperatura colore (K)	2700K	2700K	2700K	3000K	3000K	3000K	4000K	4000K	4000K
Flusso luminoso (lm)	1925lm	1935lm	1885lm	1955lm	1970lm	1880lm	2125lm	2120lm	2060lm
Angolo	24°	36°	60°	24°	36°	60°	24°	36°	60°
Codice articolo	1004462	1004463	1004464	1004470	1004471	1004472	1004478	1004479	1004480



Potenza più elevata e luce comandata
tramite sistema DALI

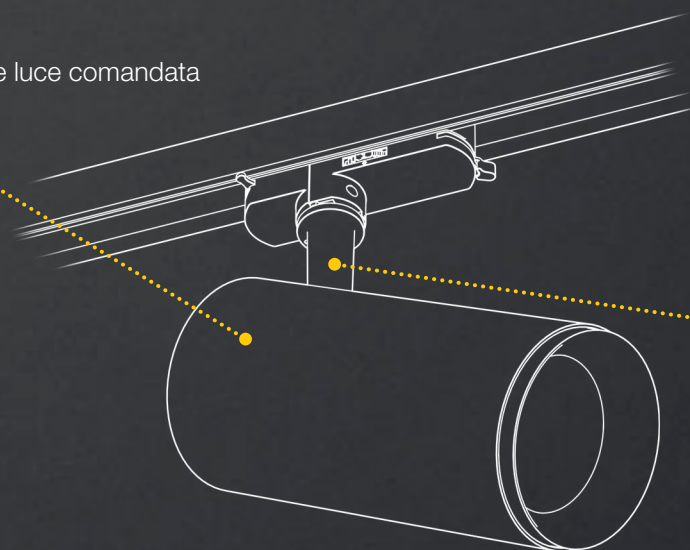

Orientabili di 90°
e ruotabili di 350°



Qui trovi il configuratore online SLV NUMINOS®:
www.ks-luce.it/numinos-configuratori-it

NUMINOS® L

DALI

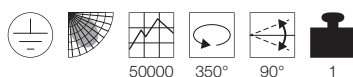

Tensione nominale (V)	220-240V ~50/60Hz 700mA
Potenza assorbita (W)	28
CRI	90
Materiale	Alluminio/plastica
L / Ø / H (cm)	21,3 / 10 / 18



■ nero

Temperatura colore (K)	2700K	2700K	2700K	3000K	3000K	3000K	4000K	4000K	4000K
Flusso luminoso (lm)	2440lm	2400lm	2475lm	2430lm	2340lm	2400lm	2675lm	2620lm	2715lm
Angolo	24°	36°	60°	24°	36°	60°	24°	36°	60°
Codice articolo	1004554	1004555	1004556	1004562	1004563	1004564	1004570	1004571	1004572

□ bianco

Temperatura colore (K)	2700K	2700K	2700K	3000K	3000K	3000K	4000K	4000K	4000K
Flusso luminoso (lm)	2440lm	2400lm	2475lm	2430lm	2340lm	2400lm	2675lm	2620lm	2715lm
Angolo	24°	36°	60°	24°	36°	60°	24°	36°	60°
Codice articolo	1004558	1004559	1004560	1004566	1004567	1004568	1004574	1004575	1004576



Ideale per l'illuminazione di base
di uffici e negozi

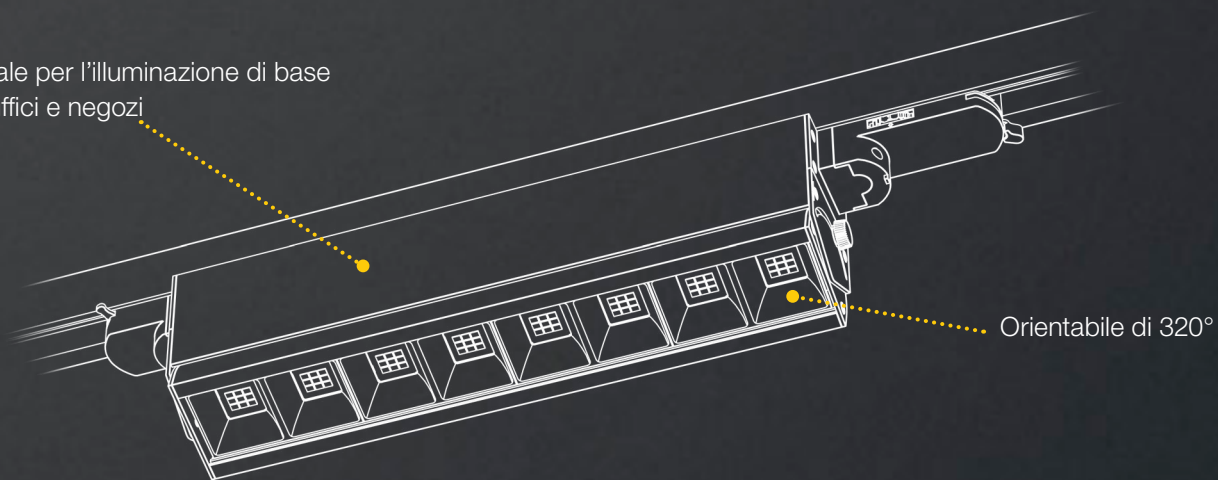

SIGHT MOVE

DALI



Tensione nominale (V)	220-240V ~50/60Hz 350mA			
Potenza assorbita (W)	26			
CRI	90			
Materiale	Alluminio/polimetilmetacrilato (PMMA)			
L/La/H (cm)	45 / 5,6 / 10,5			



	■ nero		□ bianco	
Temperatura colore (K)	3000K	4000K	3000K	4000K
Flusso luminoso (lm)	2700lm	3100lm	2700lm	3100lm
Codice articolo	1004690	1004692	1004691	1004693

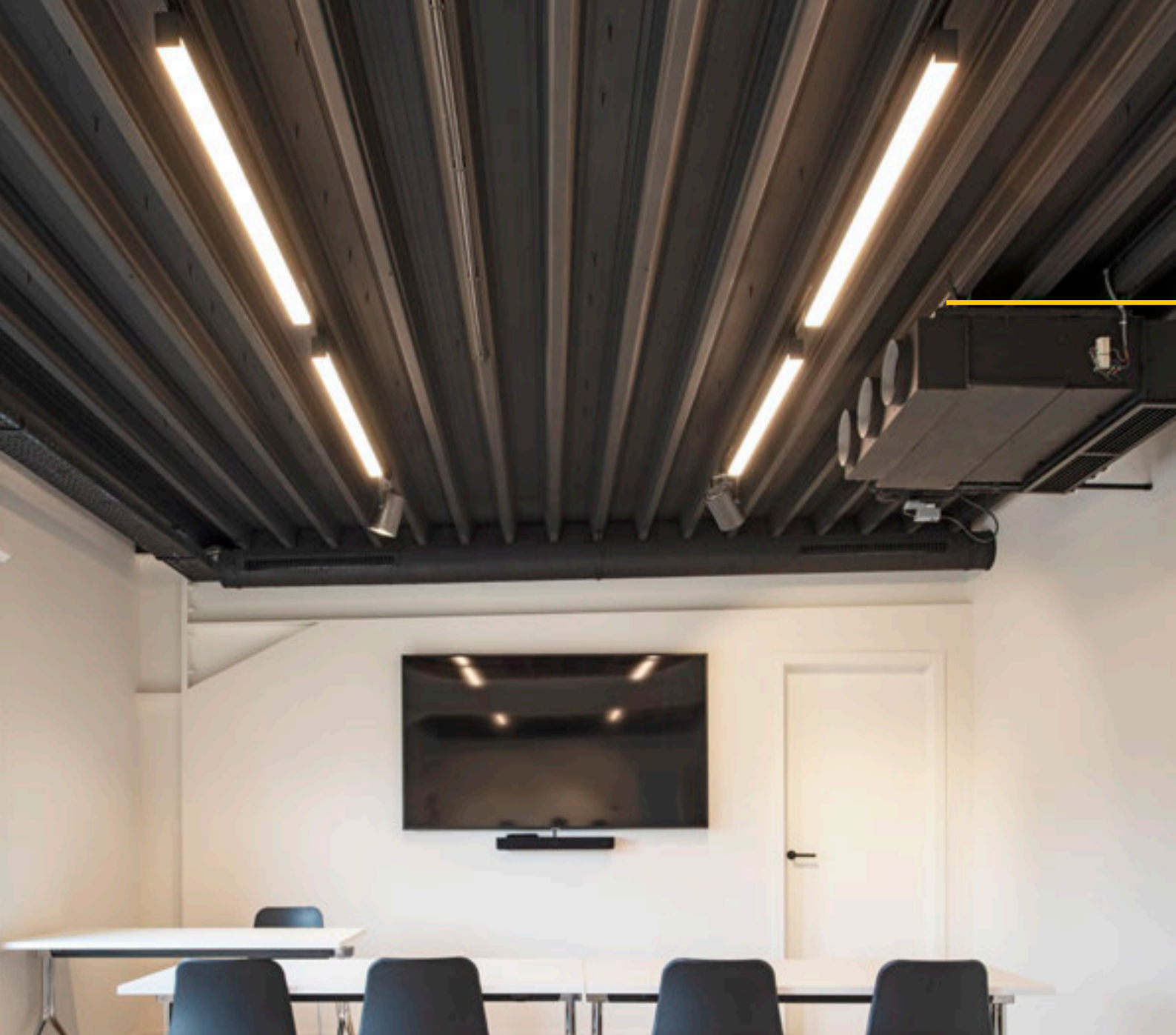

Ideale per l'illuminazione di base
di uffici e negozi



Interruttore CCT



SIGHT TRACK

DALI

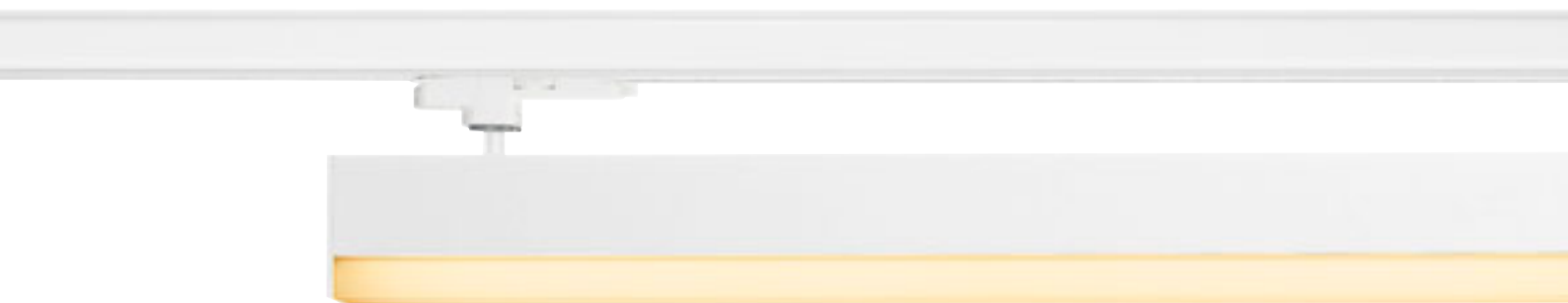

SIGHT TRACK DALI



Tensione nominale (V)	220-240V ~50/60Hz 700mA
Potenza assorbita (W)	39
CRI	90
Materiale	Alluminio/acrilico
L/La/H (cm)	114 / 4,5 / 12

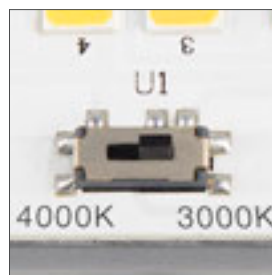

	<input checked="" type="checkbox"/> nero	<input type="checkbox"/> bianco
Temperatura colore (K)	3000K/4000K	3000K/4000K
Flusso luminoso (lm)	3000lm/3000lm	3000lm/3000lm
Codice articolo	1005397	1005399



Luce interna

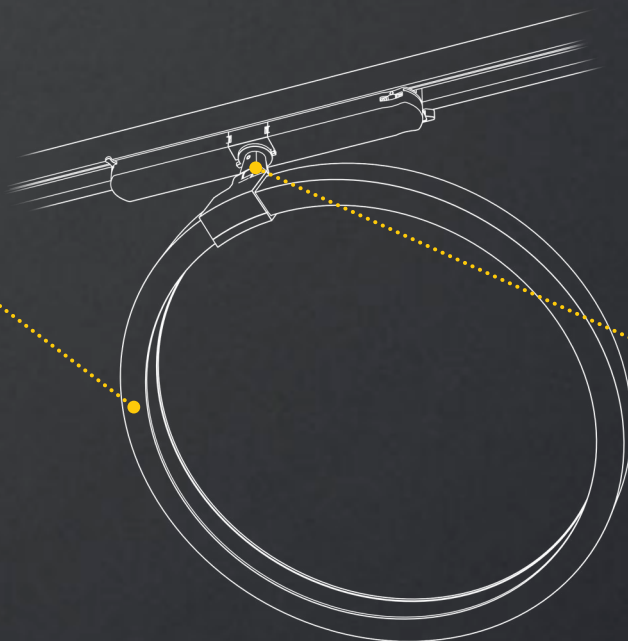

Orientabili di 100°
e ruotabili di 340°



ONE 40 TRACK

DALI



ONE 40 TRACK DALI

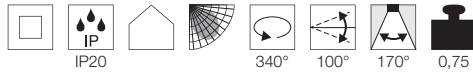

Tensione nominale (V)	220-240V ~50/60Hz 350mA			
Potenza assorbita (W)	15,2			
CRI	90			
Materiale	Alluminio			
Ø / H (cm)	40 / 10,5			



	■ nero		□ bianco	
Temperatura colore (K)	3000K	4000K	3000K	4000K
Flusso luminoso (lm)	650lm	670lm	650lm	670lm
Codice articolo	1004769	1004771	1004770	1004772



EUTRAC®

Binario a plafone trifase

Richiesta di binario standard?

Se cerchi un sistema a binario standard e di buona qualità o se lo richiede un bando di gara, il binario in alluminio EUTRAC® è il prodotto giusto. I sistemi a binario trifase ad alto voltaggio sono compatibili con le lampade SLV. La versione a plafone è disponibile in vari colori e lunghezze.

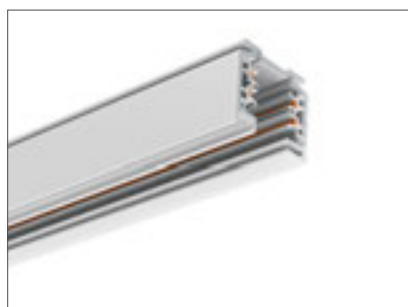

	1 m	1 m	1 m	2 m	2 m	2 m
Tensione nominale (V)	220-240V ~50/60Hz	220-240V ~50/60Hz	220-240V ~50/60Hz	220-240V ~50/60Hz	220-240V ~50/60Hz	220-240V ~50/60Hz
Intensità di corrente massima (A)	16	16	16	16	16	16
Materiale	Alluminio/ policarbonato (PC)	Alluminio/ policarbonato (PC)	Alluminio/ policarbonato (PC)	Alluminio/ policarbonato (PC)	Alluminio/ policarbonato (PC)	Alluminio/ policarbonato (PC)
Colore	■ nero	□ bianco	■ grigio	■ nero	□ bianco	■ grigio
L x P x A (cm)	100 x 3,6 x 3,2	100 x 3,6 x 3,2	100 x 3,6 x 3,2	200 x 3,6 x 3,2	200 x 3,6 x 3,2	200 x 3,6 x 3,2
Peso (kg)	1,0	1,0	1,0	2,0	2,0	2,0
Codice articolo	145100	1001510	145102	145200	1001511	145202

Produttore: EUTRAC® Stromschienen GmbH

	3 m	3 m	3 m
Tensione nominale (V)	220-240V ~50/60Hz	220-240V ~50/60Hz	220-240V ~50/60Hz
Intensità di corrente massima (A)	16	16	16
Materiale	Alluminio/ policarbonato (PC)	Alluminio/ policarbonato (PC)	Alluminio/ policarbonato (PC)
Colore	■ nero	□ bianco	■ grigio
L x P x A (cm)	300 x 3,6 x 3,2	300 x 3,6 x 3,2	300 x 3,6 x 3,2
Peso (kg)	3,0	3,0	3,0
Codice articolo	145300	1001512	145302

Produttore: EUTRAC® Stromschienen GmbH

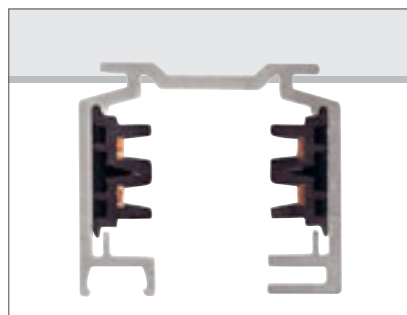

EUTRAC®

Binario a plafone trifase

Guida alla progettazione e panoramica degli accessori

Vista dei componenti dall'alto



145510
1001513
145514



145520
1001514
145524



145670
1001520
145674



145680
1001521
145684



145630
1001518
145634



145640
1001519
145644

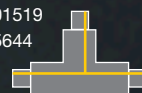

145690
1001522
145694



Esempio: terra esterna

145670
1001520
145674

145510
1001513
145514

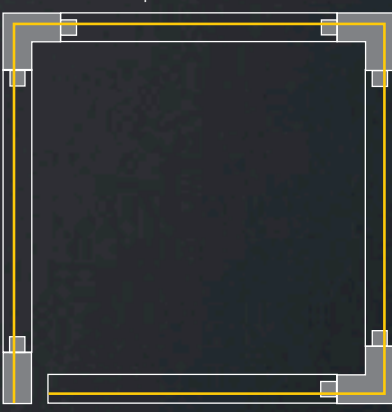

145670
1001520
145674

145680
1001521
145684

145520
1001514
145524

Esempio: terra interna

145510
1001513
145514

145640
1001519
145644

145630
1001518
145634

145680
1001521
145684

145520
1001514
145524

145670
1001520
145674

145690
1001522
145694

145680
1001521
145684

145680
1001521
145684

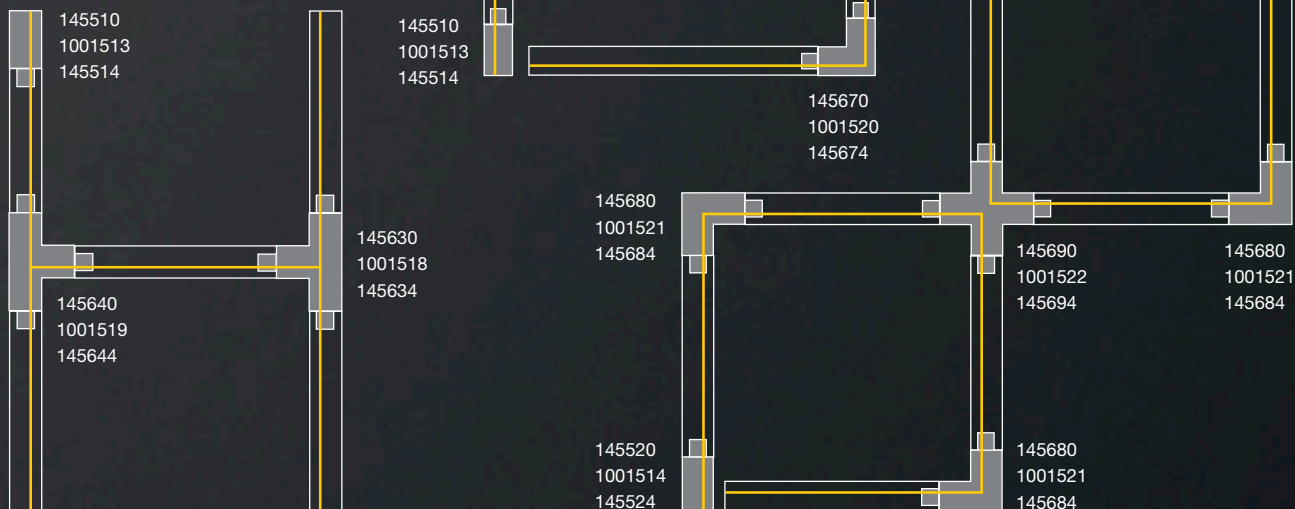

**Testata di alimentazione, terra a sinistra**

16A max. | Policarbonato (PC)
L: 11,2 cm La: 3,6 cm H: 3,2 cm

- nero Cod. art. 145510
- bianco Cod. art. 1001513
- grigio Cod. art. 145514

**Gancio di accoppiamento**

Policarbonato (PC)
L: 10 cm La: 3,6 cm H: 1,9 cm

- nero Cod. art. 145600
- bianco Cod. art. 1001523
- grigio Cod. art. 145604

**Testata di alimentazione, terra a destra**

16A max. | Policarbonato (PC)
L: 11,2 cm La: 3,6 cm H: 3,2 cm

- nero Cod. art. 145520
- bianco Cod. art. 1001514
- grigio Cod. art. 145524

**Raccordo flessibile**

16A max. | Policarbonato (PC) / acciaio
L: 22 cm La: 3,6 cm H: 3,2 cm

- nero Cod. art. 145580
- bianco Cod. art. 1001524
- grigio Cod. art. 145584

**Testata di alimentazione centrale**

16A max. | Policarbonato (PC)
L: 13 cm La: 3,6 cm H: 3,2 cm

- nero Cod. art. 145530
- bianco Cod. art. 1001515
- grigio Cod. art. 145534

**Presse**

6,3A max. | Policarbonato (PC)
L: 9,6 cm La: 6,5 cm H: 9 cm

- nero Cod. art. 145700
- bianco Cod. art. 1001525

**Raccordo longitudinale***

16A max. | Policarbonato (PC) / acciaio
L: 26 cm La: 3,6 cm H: 3,2 cm

- nero Cod. art. 145660
- bianco Cod. art. 1001517
- grigio Cod. art. 145664

**Adattatore trifase per sospensioni**

10A max. | Policarbonato (PC)

- nero Cod. art. 145990
- bianco Cod. art. 1001547
- grigio Cod. art. 145994

**Raccordo longitudinale**

16A max. | Policarbonato (PC)
L: 5,8 cm La: 1,5 cm H: 2,6 cm

- nero Cod. art. 145660
- bianco Cod. art. 1001516
- grigio Cod. art. 145664

**Staffa di fissaggio**

Alluminio
L: 5 cm La: 3,6 cm H: 1,9 cm

- nero Cod. art. 145730
- bianco Cod. art. 1001530
- grigio Cod. art. 145734

**Raccordo a L, terra interna***

16A max. | Policarbonato (PC) / acciaio
L: 15 cm La: 15 cm H: 3,2 cm

- nero Cod. art. 145680
- bianco Cod. art. 1001521
- grigio Cod. art. 145684

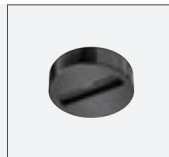
**Rosone a plafone**

16A max. | Policarbonato (PC)
H: 3,1 cm Ø: 11,9 cm

- nero Cod. art. 145830
- bianco Cod. art. 1001526
- grigio Cod. art. 145834

**Raccordo a L, terra esterna***

16A max. | Policarbonato (PC) / acciaio
L: 15 cm La: 15 cm H: 3,2 cm

- nero Cod. art. 145670
- bianco Cod. art. 1001520
- grigio Cod. art. 145674

**Calotta di chiusura**

Policarbonato (PC)
L: 3,6 cm La: 1,7 cm H: 3,2 cm

- nero Cod. art. 145590
- bianco Cod. art. 1001527
- grigio Cod. art. 145594

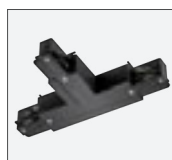
**Raccordo a T, terra interna, sinistra***

16A max. | Policarbonato (PC) / acciaio
L: 26 cm La: 18,5 cm H: 3,2 cm

- nero Cod. art. 145630
- bianco Cod. art. 1001518
- grigio Cod. art. 145634

**Tige sospensione**

Policarbonato (PC) / acciaio
L: 60 cm H: 63,5 cm Ø: 7 cm

- nero Cod. art. 145720
- bianco Cod. art. 1001529
- grigio Cod. art. 145724

**Raccordo a T, terra interna, destra***

16A max. | Policarbonato (PC) / acciaio
L: 26 cm La: 18,5 cm H: 3,2 cm

- nero Cod. art. 145640
- bianco Cod. art. 1001519
- grigio Cod. art. 145644

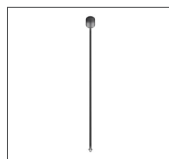
**Tige sospensione**

Policarbonato (PC) / acciaio
L: 120 cm H: 122 cm Ø: 7 cm

- nero Cod. art. 145710
- bianco Cod. art. 1001528
- grigio Cod. art. 145714

**Raccordo a X***

16A max. | Policarbonato (PC) / acciaio
L: 26 cm La: 26 cm H: 3,2 cm
2 circuiti elettrici separati

- nero Cod. art. 145690
- bianco Cod. art. 1001522
- grigio Cod. art. 145694

**Cavo di sospensione, 2 pezzi**

Acciaio inox/ottone
L: 500 cm | max. 10 kg

- nichel Cod. art. 1002845

* con possibilità di alimentazione



Binario da incasso trifase e accessori

Per progetti dove l'estetica è di fondamentale importanza il modello di binario trifase da incasso EUTRAC® è la soluzione ideale in quanto molto discreta.

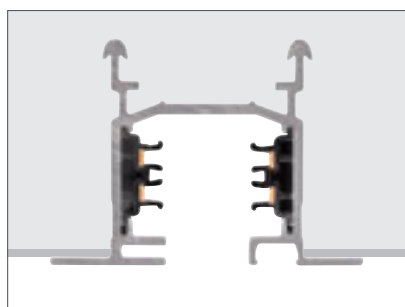

	2 m	3 m
Tensione nominale (V)	220-240V ~50/60Hz	220-240V ~50/60Hz
Intensità di corrente massima (A)	16	16
Materiale	Alluminio/ policarbonato (PC)	Alluminio/ policarbonato (PC)
Colore	<input type="checkbox"/> bianco	<input type="checkbox"/> bianco
L x P x A (cm)	200 x 5,9 x 4,1	300 x 5,9 x 4,1
Larghezza incasso (cm)	4	4
Peso (kg)	2,6	3,9
Codice articolo	1001531	1001532

Produttore: EUTRAC® Stromschienen GmbH



Testata di alimentazione, terra sinistra
16A max. | Policarbonato (PC) / acciaio
L: 12,2 cm La: 6 cm H: 3,4 cm

bianco Cod. art. 1001533

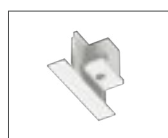

Calotta di chiusura
Policarbonato (PC)
L: 2,7 cm La: 6 cm H: 3,2 cm

bianco Cod. art. 1001538

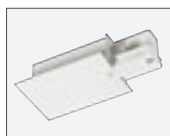

Testata di alimentazione, terra destra
16A max. | Policarbonato (PC) / acciaio
L: 12,2 cm La: 6 cm H: 3,4 cm

bianco Cod. art. 1001534



Raccordo longitudinale con stabilizzatore
16A max. | Policarbonato (PC) / acciaio
L: 6,2 cm La: 2,5 cm H: 2,7 cm

bianco Cod. art. 1001539

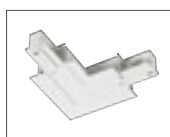

Raccordo a L, terra esterna
16A max. | Policarbonato (PC) / acciaio
L: 16 cm La: 16 cm H: 3,2 cm
Con possibilità di alimentazione

bianco Cod. art. 1001536

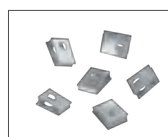

Clip per ancoraggio a soffitto
Acciaio
L: 2 cm La: 1 cm H: 2,5 cm

grigio Cod. art. 145551

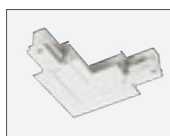

Raccordo a L, terra interna
16A max. | Policarbonato (PC) / acciaio
L: 16 cm La: 16 cm H: 3,2 cm
Con possibilità di alimentazione

bianco Cod. art. 1001537





Adattatore trifase per sospensioni
10A max. | Policarbonato (PC)

bianco Cod. art. 1001547

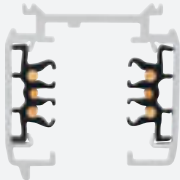

COMPATIBILITÀ

Binari elettrificati trifase

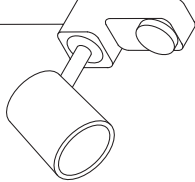
Compatibile con apparecchi/adattatori di:

 Binari e accessori S-Track DALI	Utilizzo	SLV	Global/Nordic
			
no DALI		✓	✓
DALI		✓	✓

Compatibile con binari e accessori di:

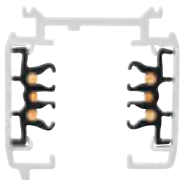
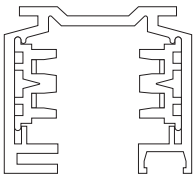
 Apparecchi S-Track DALI	Utilizzo	SLV S-TRACK	Global/Nordic
			
no DALI		✓	✓
DALI		✓	✓

- ★ Con riserva di preventiva verifica con campioni di prova
- ★★ Senza funzionalità DALI

Dati forniti senza alcuna assunzione di responsabilità.

I dati tecnici e le misure possono essere modificati in qualsiasi momento senza preavviso.

Verificare la funzionalità con campioni già in fase di progettazione.

La compatibilità si riferisce solo a binari e apparecchi.

Non abbinare binari e accessori di produttori diversi.

I sistemi a binario SLV e i loro accessori hanno una compatibilità elevata con diverse aziende. Tra queste: EUTRAC®, Zumtobel, Erco e LTS ONETrack. Si consiglia una verifica preventiva con binari e apparecchi.

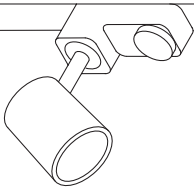
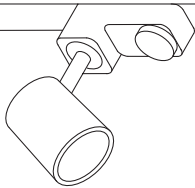
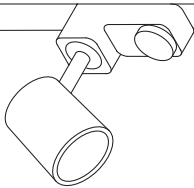
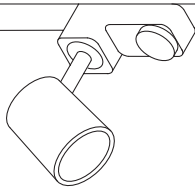
	EUTRAC®	Zumtobel	Erco	LTS ONETTrack
				
★	✓	✓	✓	
✗	✓	✓	✓	

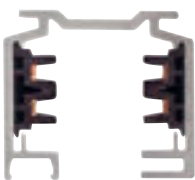
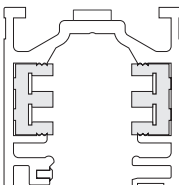
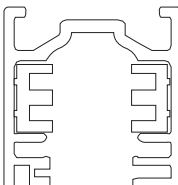
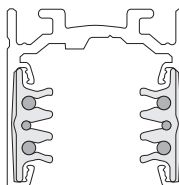
	EUTRAC®	Zumtobel	Erco	LTS ONETTrack
				
✓	✓	✓	✓	
✓★★	✓	✓	✓	



Hai trovato l'ispirazione?

Se hai scelto una tipologia di configurazione sei già a buon punto. Le opzioni di selezione dei componenti sono preimpostate nel modo ottimale.

NUMINOS®

Configuratore online.

Il sistema di configurazione SLV NUMINOS® rende possibile la scelta del faretto in pochi, semplici passi.

NUMINOS® è un sistema di apparecchi perfettamente combinati fra loro, che garantisce caratteristiche di illuminazione costanti e un moderno design adatto a tutte le applicazioni. Il nostro configuratore online ti aiuta a scegliere tra una vasta scelta di modelli con dimensioni, potenze e accessori diversi, per soddisfare le esigenze di qualsiasi progetto.

Oltre agli spot da binario trifase, i faretto NUMINOS® sono disponibili anche in versione da incasso con ottica fissa e orientabile, da plafone o sospensione.



Qui trovi il configuratore online SLV NUMINOS®:
www.ks-luce.it/numinos-configuratori-it



SPOT

Disponibili con corpo di tre dimensioni (65x155mm, 85x175mm, 100x203mm) con modulo LED ad elevate prestazioni e in tre temperature di colore (2700K, 3000K, 4000K).

Grazie al LED driver integrato (disponibile in versione dimmerabile a taglio di fase o DALI), tutti gli spot sono adatti alla connessione diretta con l'alimentazione di rete a 230V.

Lenti a scelta con apertura del fascio luminoso di 24°, 36° o 60°.

NUMINOS® Gli spot sono disponibili nella versione a plafone fissa oppure orientabile, come sospensioni e come spot per il sistema a binario elettrificato trifase.



Hai ancora dubbi?

Scansiona per visualizzare un video che mostra quanto sia facile configurare gli apparecchi NUMINOS®.





LEGENDA DEI SIMBOLI



CARATTERISTICHE DEL PRODOTTO



Possibilità di sostituzione del LED in assenza di danni all'apparecchio.

- LED sostituibile da una persona qualificata



Peso del prodotto in chilogrammi (kg)



Rotazione e orientabilità in gradi:

- Orientabilità sull'asse orizzontale
- Orientabilità sull'asse verticale



Apertura del fascio luminoso

Indica l'angolo di apertura del fascio di luce



Durata media di una sorgente luminosa in ore.



Mantenimento del flusso luminoso

Indica la percentuale di decadimento del flusso luminoso di un LED, riferita al periodo indicato.



Curva fotometrica disponibile

DATI TECNICI DI SICUREZZA



Classi di isolamento elettrico

- Classe di protezione I / collegamento al conduttore di protezione (messa a terra)
- Classe di protezione II / Apparecchi a doppio isolamento

AMBITO DI APPLICAZIONE · MONTAGGIO



Classe di protezione IP

Indica il grado di protezione contro l'intrusione di particelle solide e l'accesso di liquidi



Impiego **esclusivamente** in interni

SIMBOLI SPECIALI



Indica prodotti

- con **LED** integrato



Sistema di connessione

- Indica i prodotti smart gestibili coi seguenti protocolli:
- DALI

Fonti iconografiche

© SLV GmbH, 2021

© Chlorophylle | Adobe Stock



KS Licht- u. Elektrotechnik GmbH
Manderscheidstr. 8c
45141 Essen

Tel.: +49 (0)201-89924-0
Fax: +49 (0)201-89924-124

Internet: www.KS-Germany.com
Email: Verkauf@KS-Germany.com