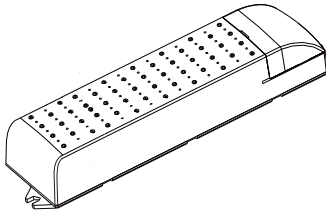
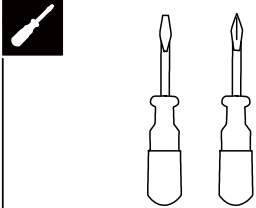
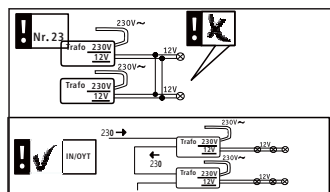
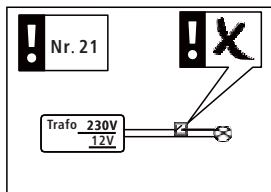
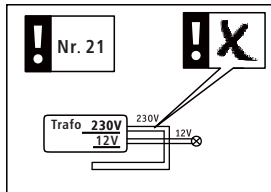
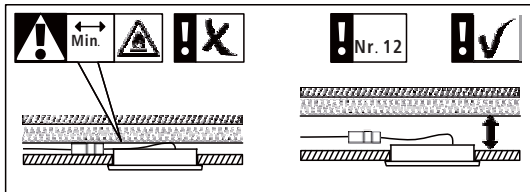
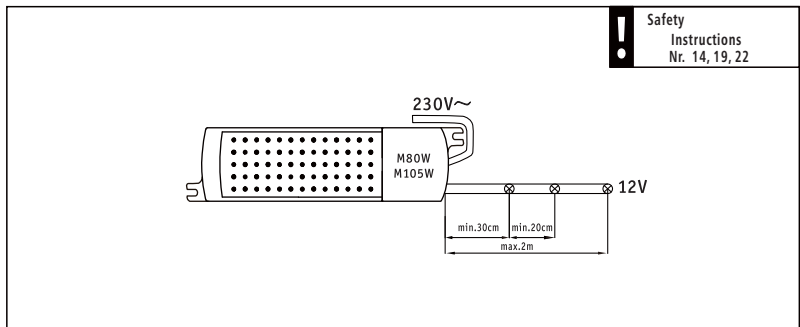
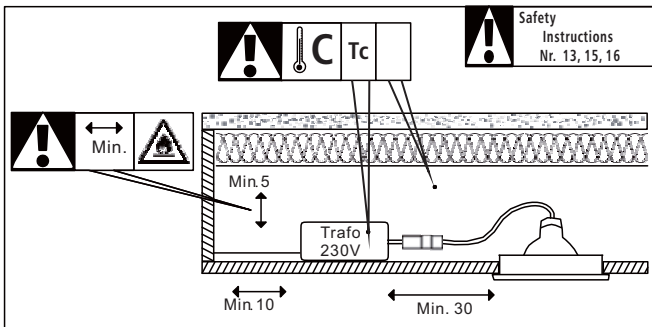
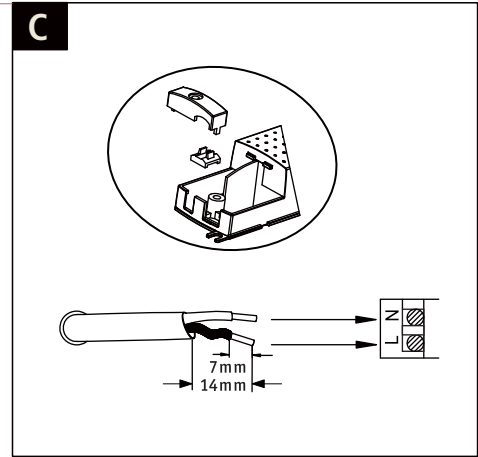
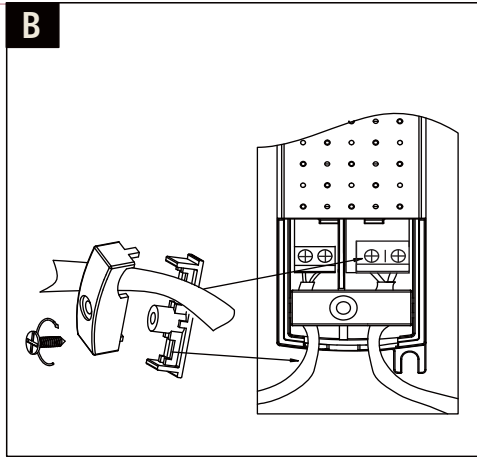
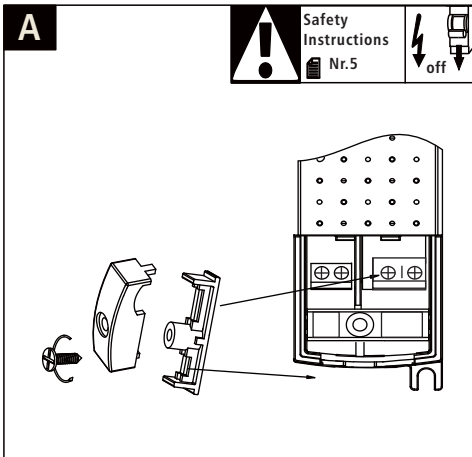
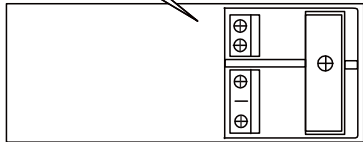
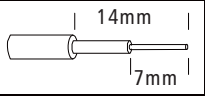
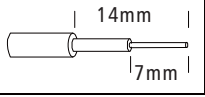

Art.-Nr.: 977.53
 977.54

(+MA 197) PDG 10/16

CE UK CA

<p>Trafo 80/105VA Art.-Nr.: 977.53 977.54</p>	<p>Safety Instructions Nr. 28a/b</p>	<p>R, L, C</p>	<p>80VATC: +75°C 105VATC: +80°C</p>	<p>Ta -20 +50°C</p>
<p>12V 230V</p> 	<p>230V PRI</p> 	<p><input checked="" type="checkbox"/> H03VVH2-F <input checked="" type="checkbox"/> H05VVH2-F } 2 × 0.75mm² <input checked="" type="checkbox"/> NYM3 × 2.5mm²</p>	<p>min. 2x0,75mm²</p>	
	<p>12V SEC</p> 	<p>min. H03VVH2-F 1.0mm² × 2</p>	<p>min. 2x0,75mm²</p>	